

VEGGI MASTER

140-320

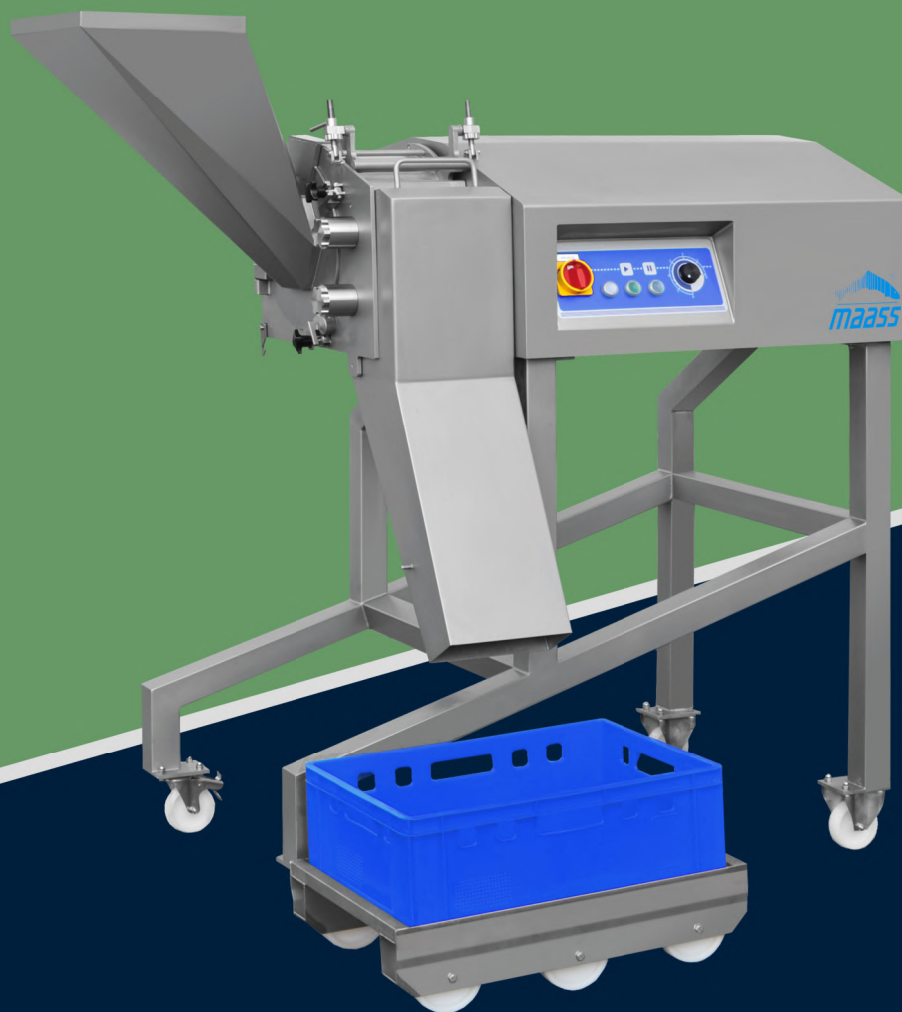

Die beste Wahl für kontinuierliches Schneiden von Gemüse und Obst in Würfel, Streifen und Scheiben

- Kompaktes Design für geringen Platzbedarf
- einfache Bedienung für müheloses Arbeiten und geringe Einarbeitungszeit
- Schneidqualität für höchste Ansprüche
- Kleine Würfelgrößen schon ab 3 mm / 4 mm
- Maschinengestell aus rostfreiem Edelstahl
- Hoher Sicherheitsstandard nach gültigen internationalen Normen
- Fahrbar mit Lenkrollen
- Wasseranschluss zum Durchspülen während des Schneidens
- Stufenlos regelbare Drehzahl

The best choice for continuous cutting of vegetables and fruits in cubes, strips and slices

- Compact machine design for small space requirements
- Simple operation for easy working and short time training
- The cutting quality fulfils highest requirements
- Small cutting sizes starting from 3mm / 4 mm
- Machine body made from stainless steel
- High safety standard according to valid international regulations
- Mobile on wheels
- Water connection for rinsing during cutting
- Speed infinitely variable

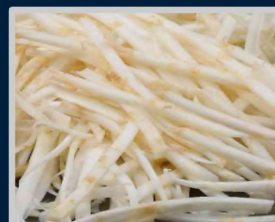
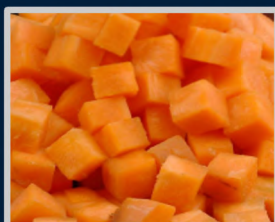

CUTTING OPTIONS

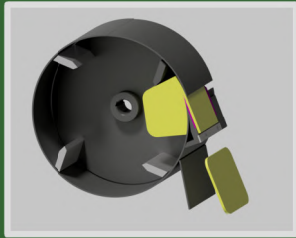

Schneiden von Scheiben
mit dem Trennmesser
*Cutting of slices
with the block knife*

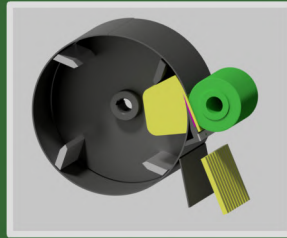

Schneiden von Streifen
mit Trennmesser und oberen Kreismessern
*Cutting of strips
with block knife and upper circular knives*

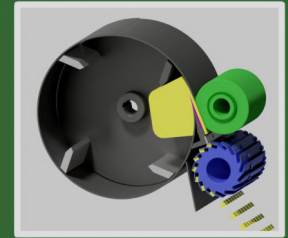

Schneiden von Würfeln
mit Trennmesser, oberen Kreismessern
und unteren Quermessern
*Cutting of cubes
with block knife, upper circular knives and
lower cross knives*

MEASURES

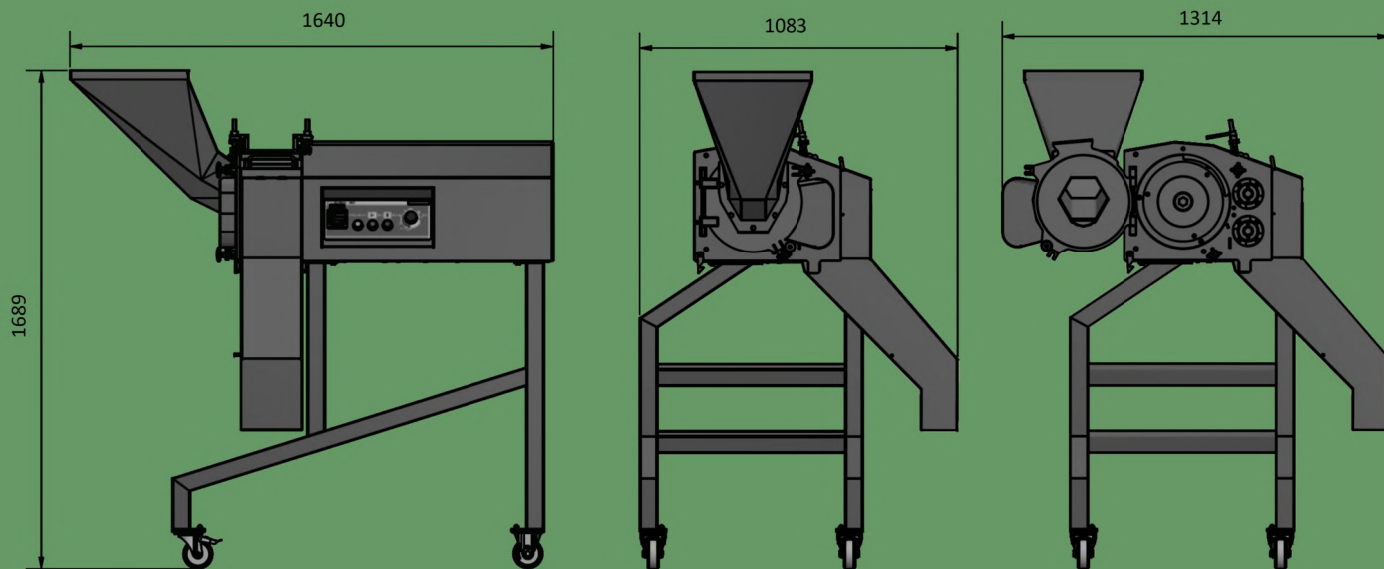

TECHNICAL DATAS

Durchsatz max. (abhängig von Würfelgröße und Produkt)	<i>throughput max. (depend on cube size and product)</i>	kg/h	1.500
Anschlusswert	<i>connected load</i>	kW	1,5
Durchmesser Einfülltrommel	<i>diameter of infeed drum</i>	mm	320
Breite Einfülltrommel	<i>width of infeed drum</i>	mm	140
Schneidgrößen	<i>cutting sizes</i>	mm	3 – 20
Drehzahl	<i>speed</i>		<i>stufenlos regelbar / variable</i>
Gewicht	<i>weight</i>	kg	240

RUDOLF MAASS + PARTNER GmbH
Warliner Str. 8
D-17034 Neubrandenburg
Germany
Phone: 0049 (0)395 77 99 160
Fax: 0049 (0)395 77 99 220
info@maass-slicers.de
www.maass-slicers.de

